

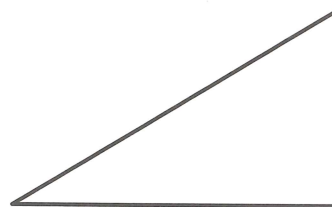

KOTIRANJE

1. Upoštevaj pravila kotiranja in se preizkusi v kotiranju preprostih likov (kvadrat, pravokotnik, krog, trikotnik).

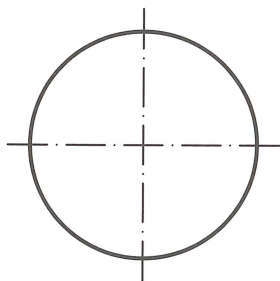
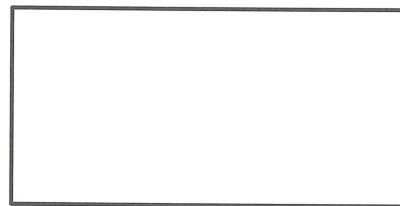
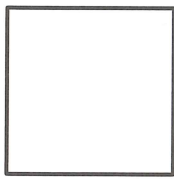

2. Kotiraj lik z luknjo.

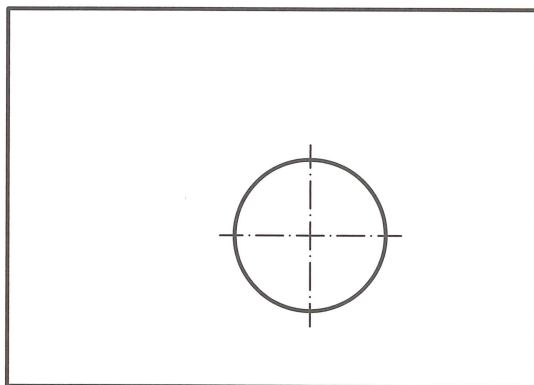

3. a) Kotiraj vzporedno.

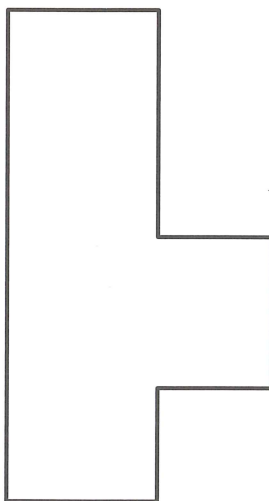

b) Kotiraj zaporedno.

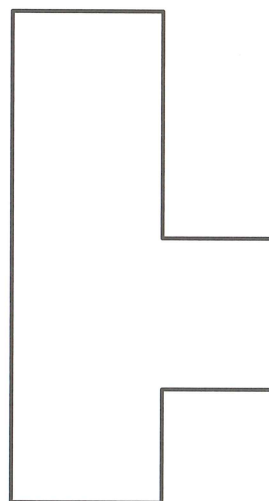

4. Preizkusi se v kotiranju zahtevnejših likov.

