



OBDELAVA KOVIN

CILJI

- SPOZNAME OSNOVNE POSTOPKE OBDELAVE KOVIN
- RAZLIKUJEMO RAZSTAVLJIVE IN NERAZSTAVLJIVE ZVEZE
- RAZLOŽIMO NAMEN IN VRSTE POVRŠINSKE ZAŠČITE KOVIN

OBDELAVE KOVIN

OBDELOVALNI POSTOPKI

OBLIKOVANJE

PREOBLIKOVANJE

OPLEMENITENJE

SPAJANJE

ODREZAVANJE



litje

kovanje
valjanje
vlečenje
rezanje
stiskanje
upogibanje
krivljenje ...

**TERMIČNE
OBDELAVE**

**KOVINSKE
PREVLEKE**
kromiranje
cinkanje
kositranje

**NEKOVINSKE
PREVLEKE**
barvanje
plastificiranje ...

**RAZSTAVLJIVE
ZVEZE**
vijačenje
kovičenje

**NERAZSTAVLJIVE
ZVEZE**
varjenje
lotanje
lepljenje

ROČNO
piljenje
žaganje

STROJNO
struženje
rezkanje
vrtanje
povrtavanje
brušenje
žaganje
pehanje
skoblanje

LITJE

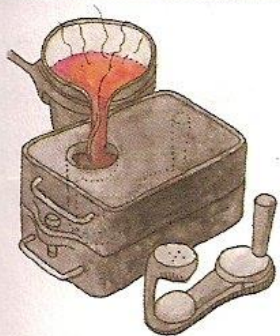

UPOGIBANJE

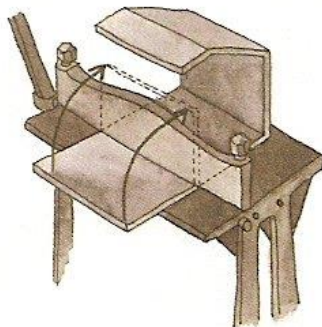

REZANJE

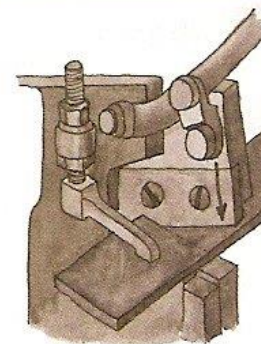

SPAJANJE

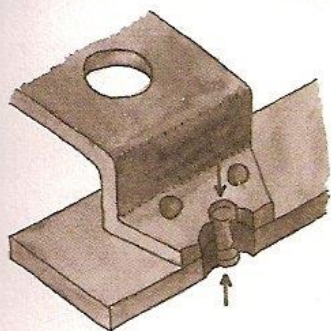

POVRŠINSKA ZAŠČITA



TERMIČNA OBDELAVA

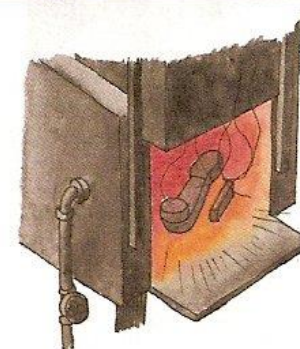

MERJENJE

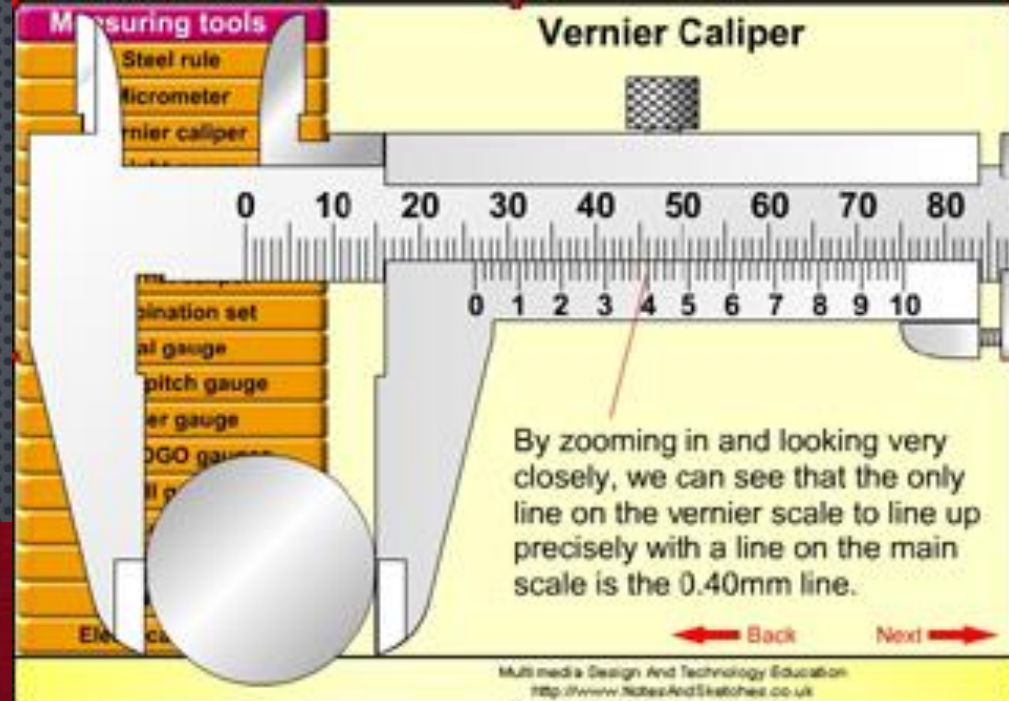

- MERILNI TRAK
- KLJUNASTO MERILO

VAJA

- VAJA ZA MERJENJE ZUNANJIH IN NOTRANJIH PREMEROV, TER GLOBIN LUKENJ.
- NASTAVITE VREDNOSTI: 33,5MM ; 45,9MM

ZARISOVANJE

- ZARISOVALNA IGLA
- SVINČNIK, ALKOHOLNI FLOMASTER
- KOVINSKO RAVNILO
- KOVINSKO ŠESTILO
- KOTNIK
- TOČKALO



ZARISOVANJE Z ZARISNO IGLO

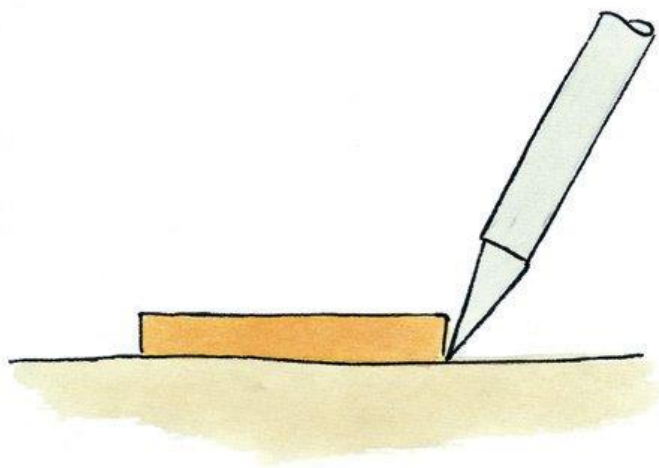

PRAVILNO

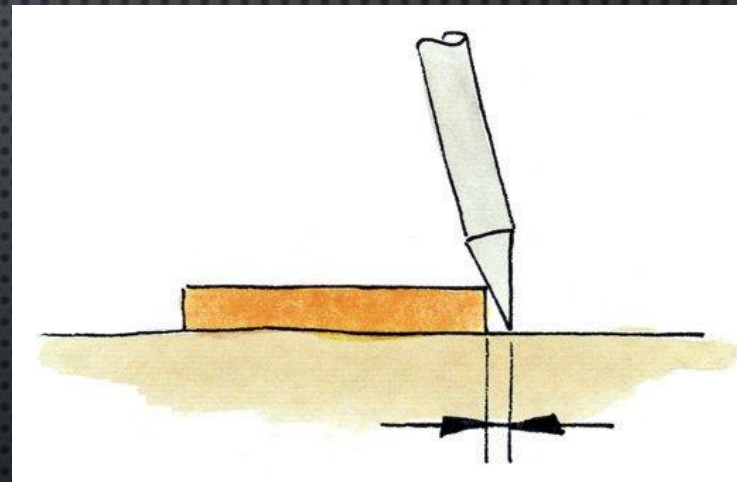

NAPAČNO

ZARISOVANJE S ŠESTILOM

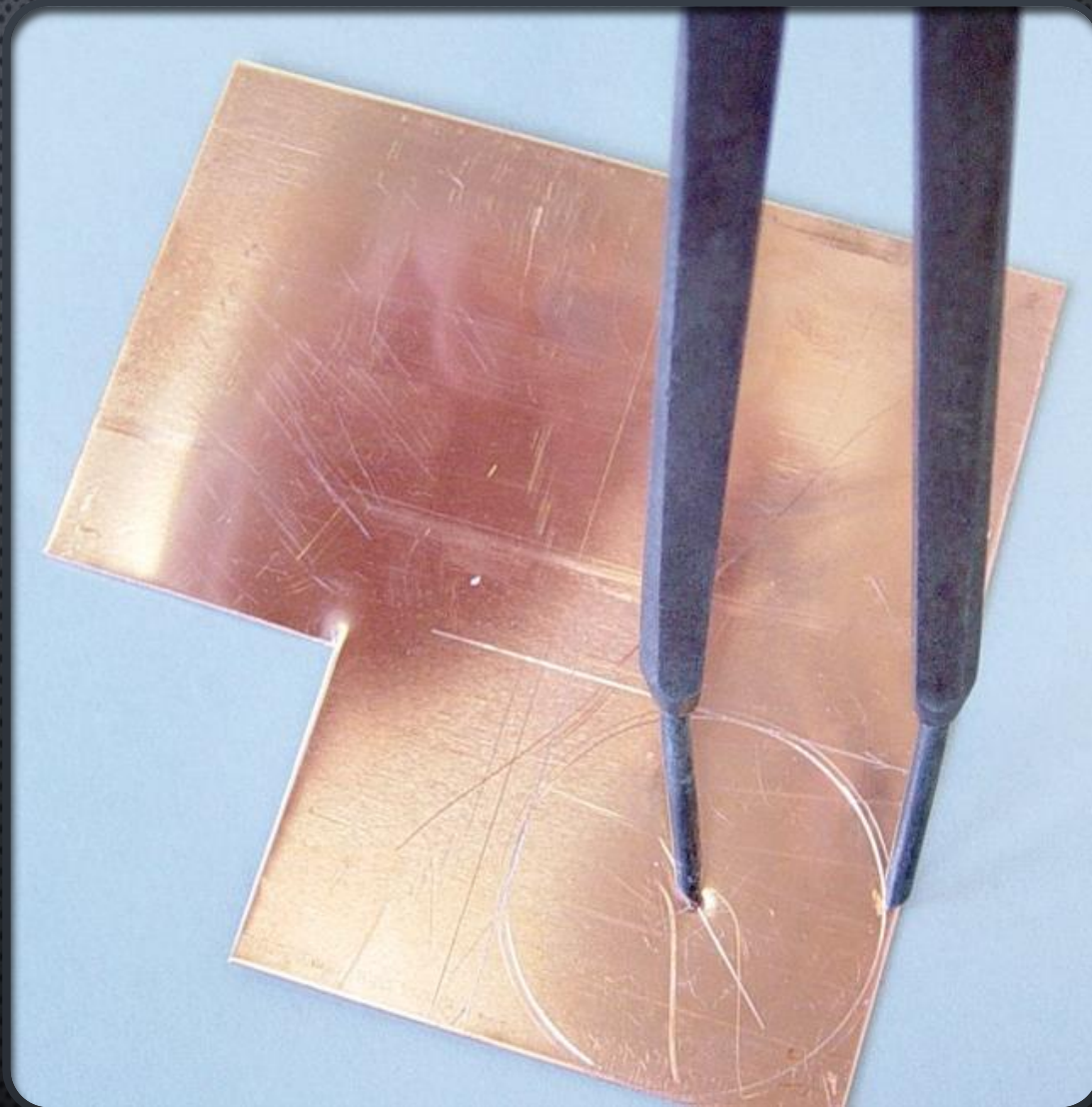

TOČKANJE S TOČKALOM

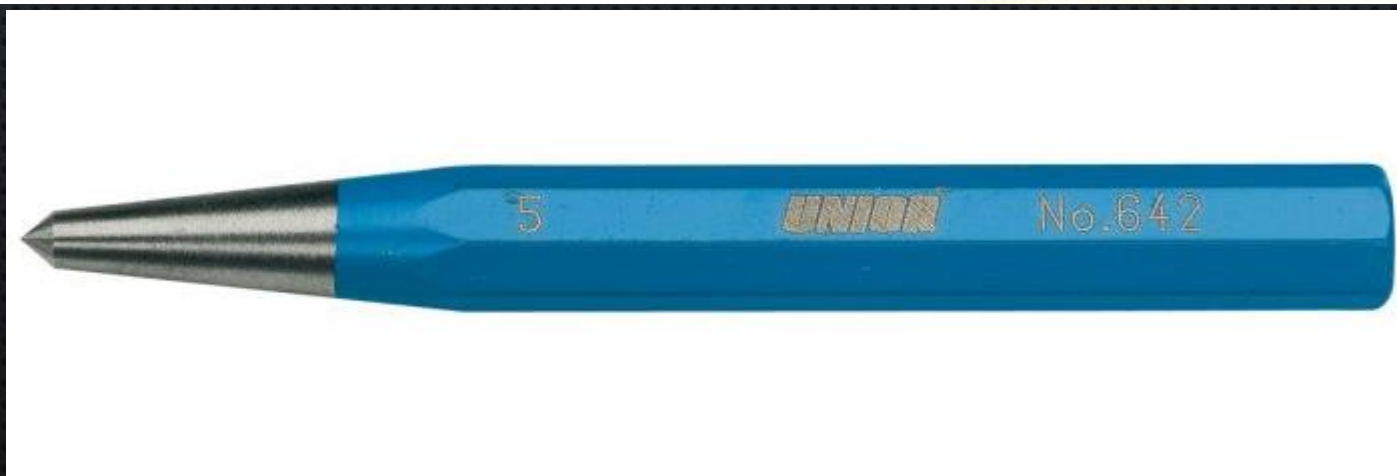
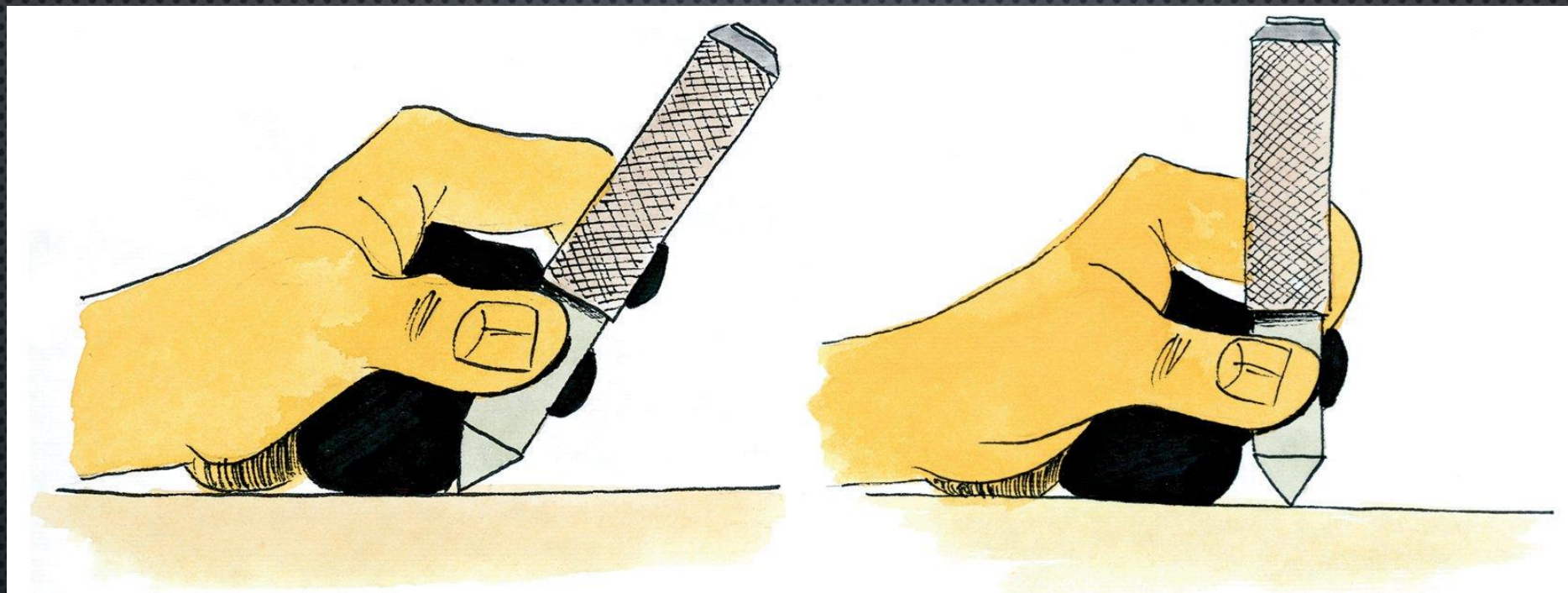

ODREZAVANJE

- ŽAGANJE
- VRTANJE
- PILJENJE
- BRUŠENJE
- STRUŽENJE



ŽAGANJE

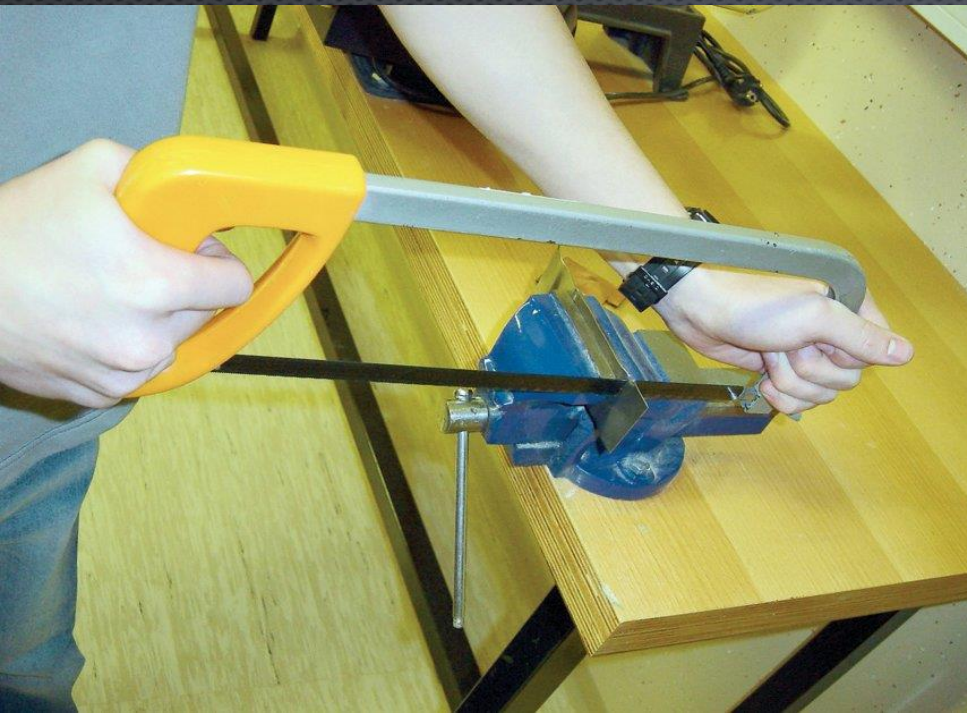

PRAVILNA DRŽA ŽAGE IN
ŽAGANJE

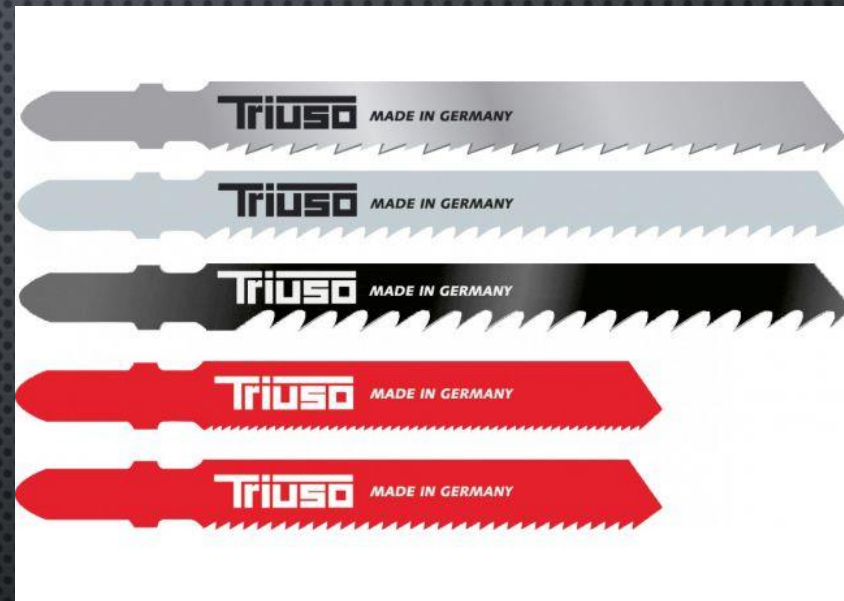

DROBNI ZOBICI NA ŽAGI

VRTANJE



SVEDER



STEBRNI VRTALNI STROJ

PILJENJE

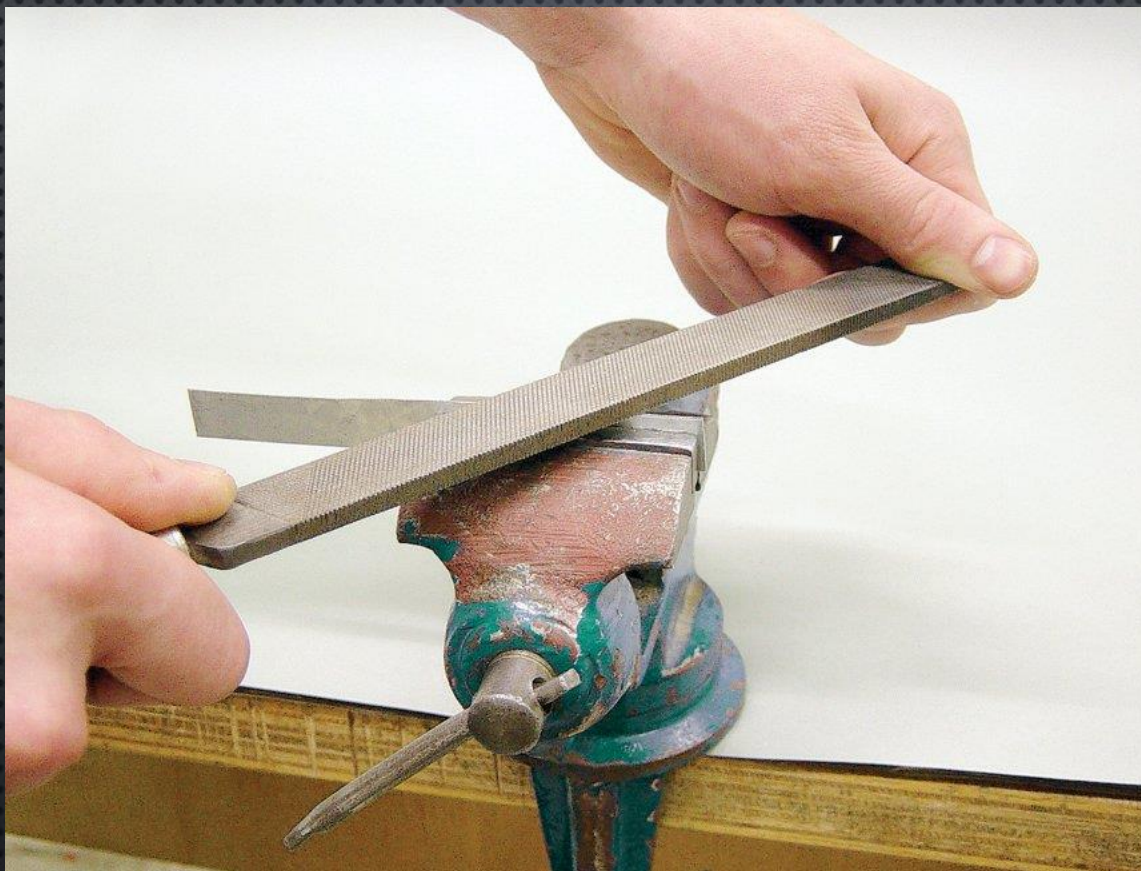

PILJENJE OBDELOVANCA

BRUŠENJE



ROČNI BRUSILNI STROJ S KOTNIM
PRENOSOM – KOTNA BRUSILKA



MIZNI KOLUTNI BRUSILNI
STROJ

STRUŽENJE

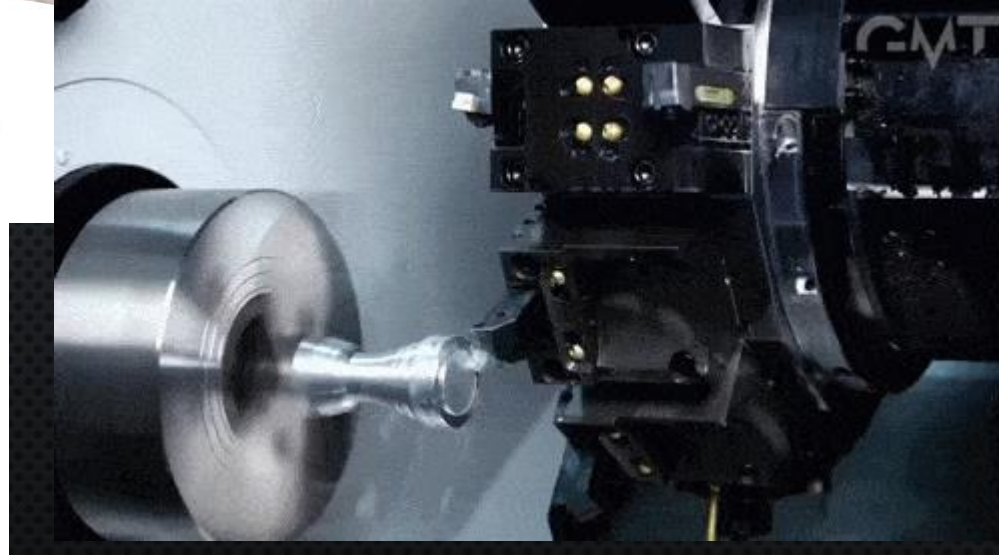
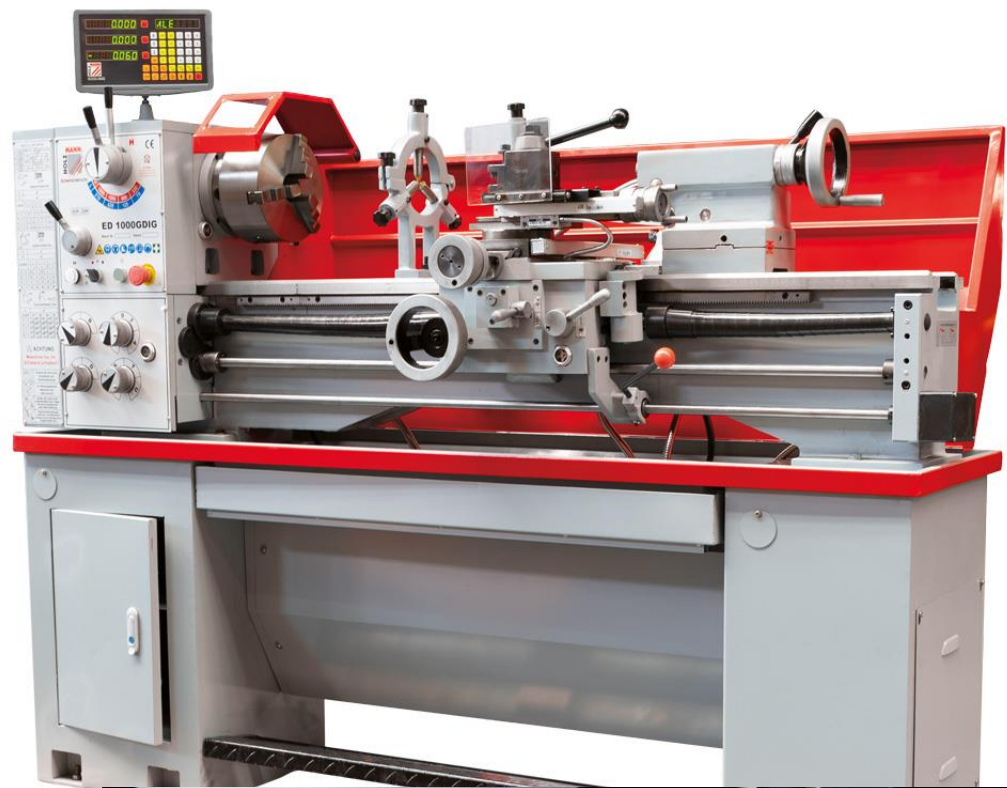

PREOBLIKOVANJE

- KRIVLJENJE
- REZANJE
- KOVANJE

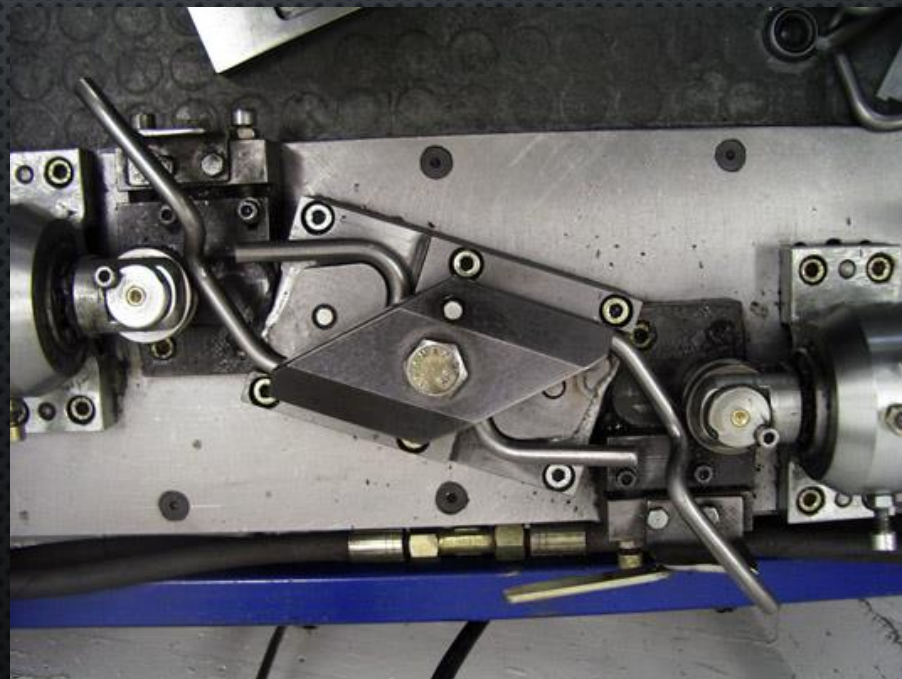

KRIVLJENJE

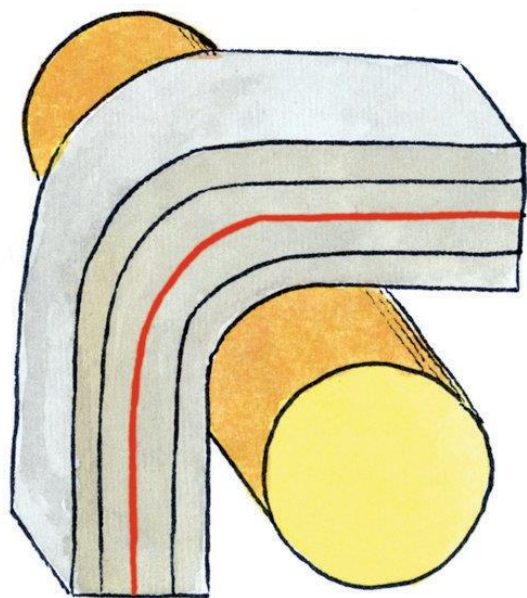

KRIVLJENJE



PRIPOMOČKI ZA KRIVLJENJE

KRIVLJENJE PLOČEVINE



REZANJE PLOČEVINE - STRIŽENJE



ŠKARJE ZA PLOČEVINO

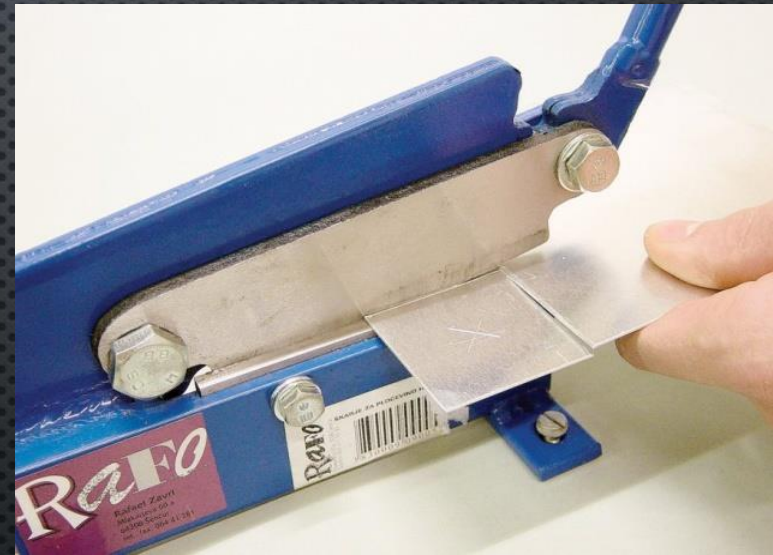

VZVODNE ŠKARJE

KLEPANJE (VLEČENJE KOVINE)

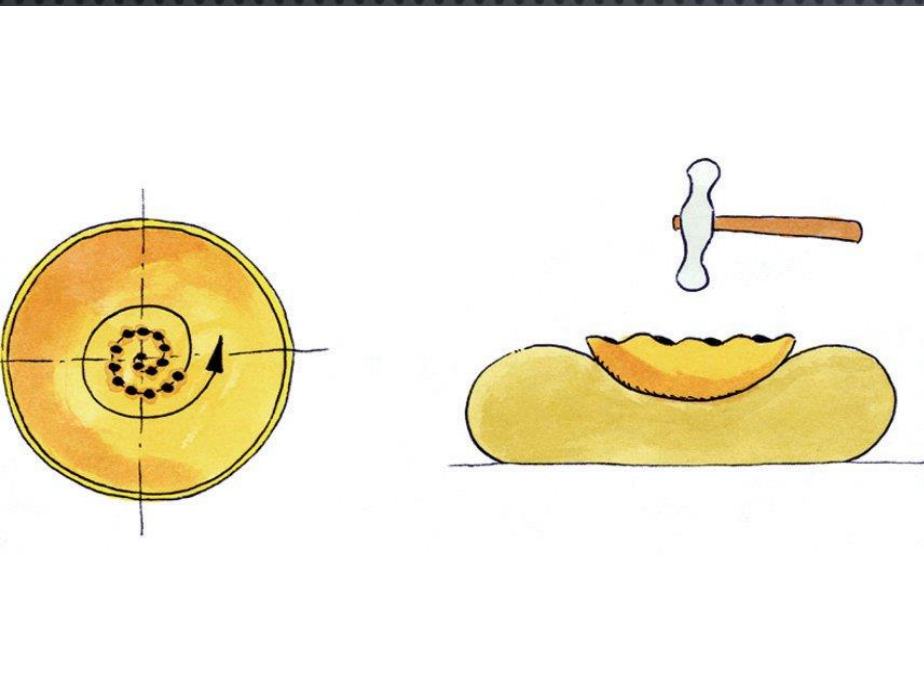

KLEPANJE

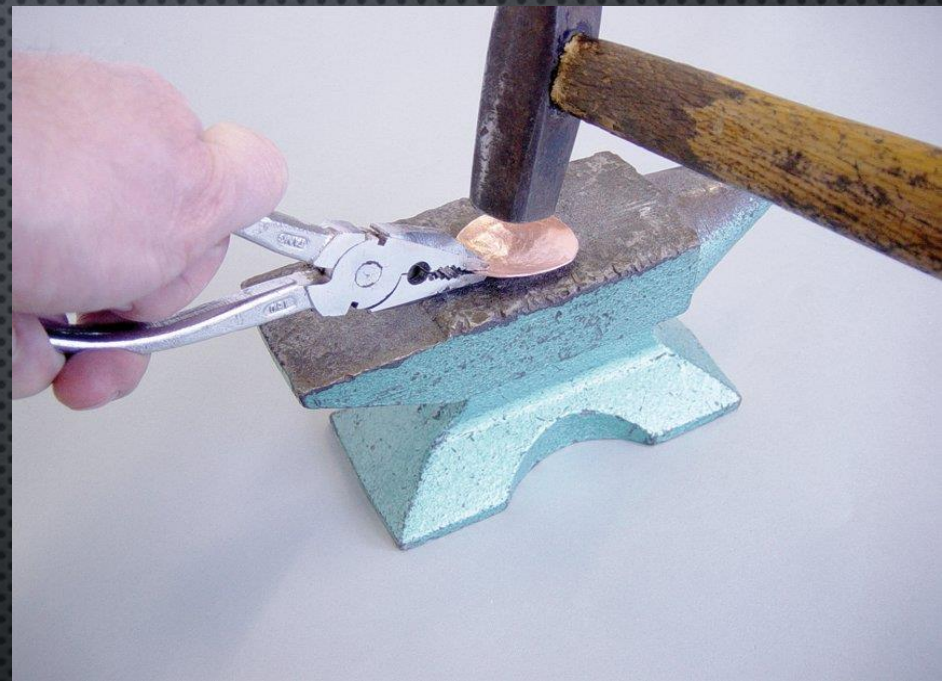

OZ. TANJENJE PLOČEVINE

SPAJANJE KOVIN

RAZSTAVLJIVI
SPOJI

VIJAK IN
MATICA

SAMOREZNI
VIJAK

DELNO RAZTALJIVI
SPOJI

KOVICE

SLEPE
KOVICE

NERAZTALJIVI SPOJI

LEPLJENJE

VARJENJE

LOTANJE
ALI
SPAJKANJE

RAZSTAVLJIVI SPOJI



VIJAK IN MATICA



VIJAK Z ZAREZO



SAMOREZNI VIJAK

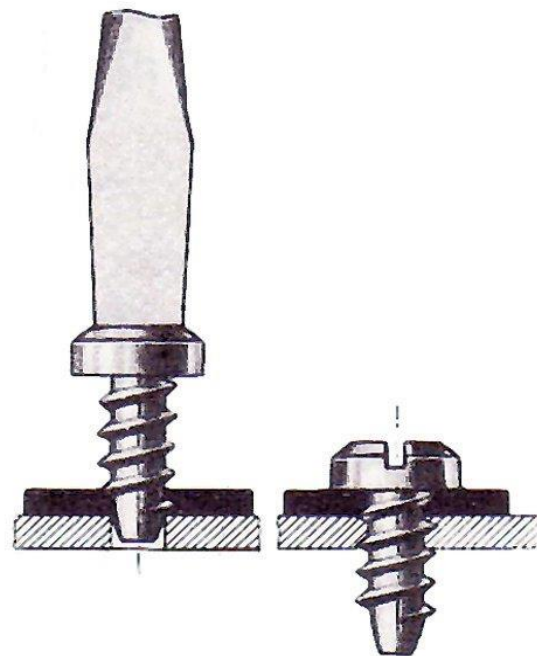

VIJAK ZA PLOČEVINO

NERAZSTAVLJIVI SPOJI - KOVIČENJE

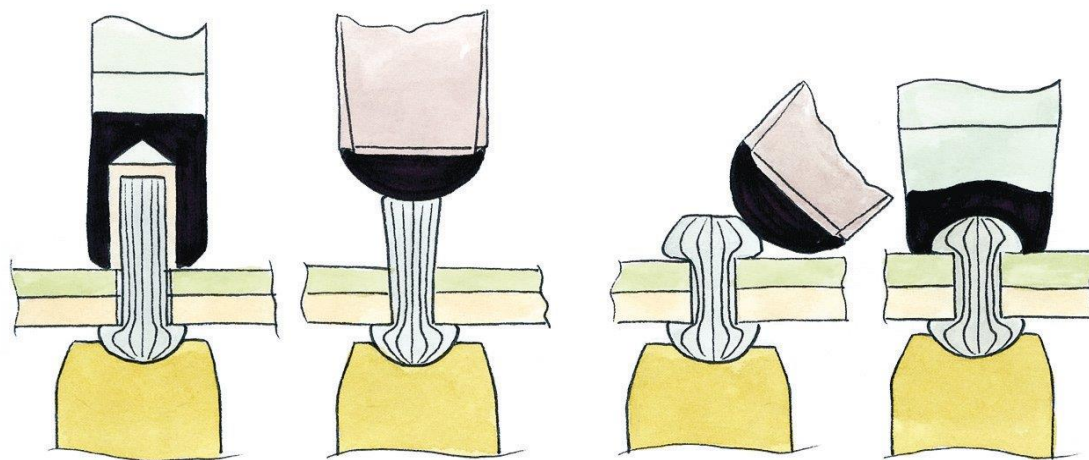



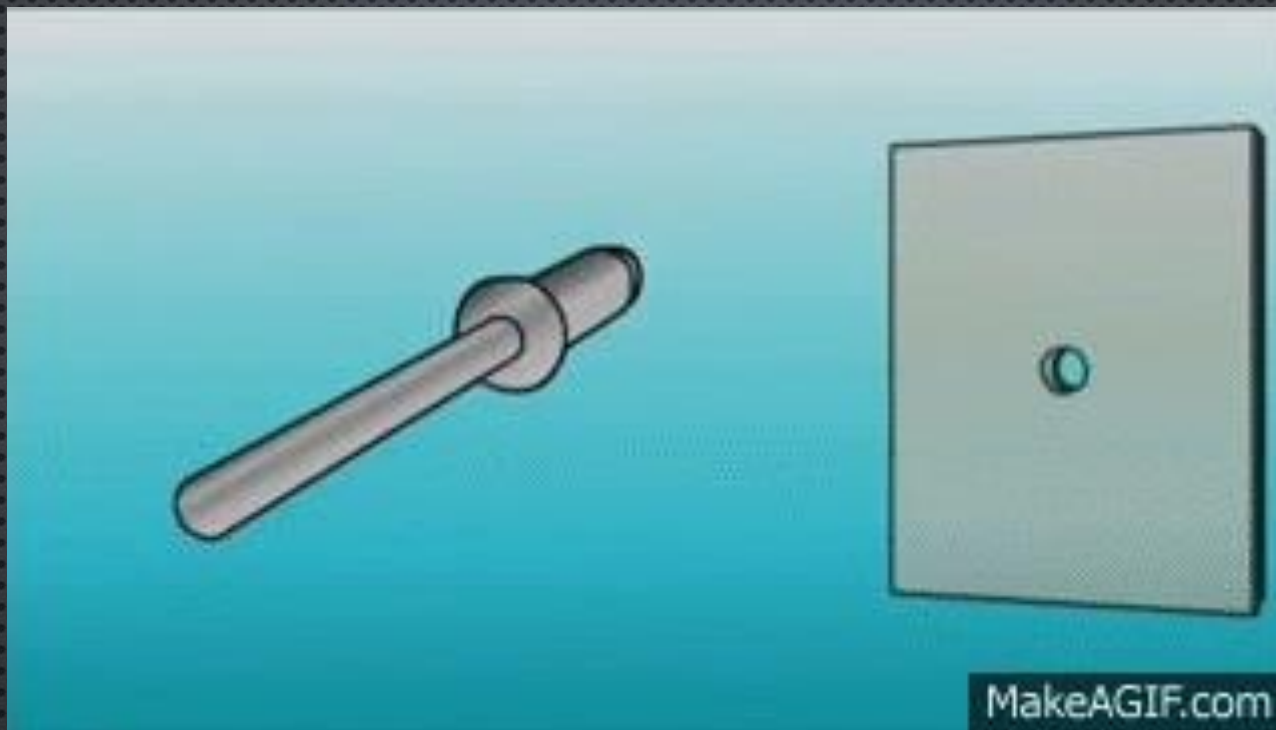

SLEPA KOVICA

NERAZSTAVLJIVI SPOJI - LOTANJE ALI SPAJKANJE



LOTANJE

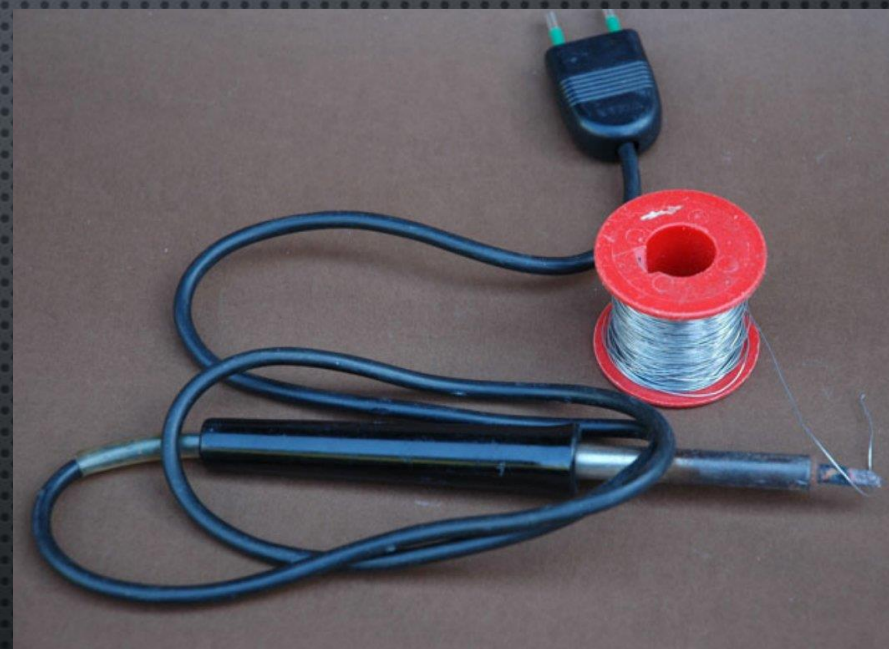

SPAJKALNIK - ORODJE ZA
LOTANJE

VARJENJE



VARJENJE



VARILNI STROJ

LEPLJENJE



STROJNO LEPLJENJE



LEPILO ZA KOVINE

POVRŠINSKA ZAŠČITA

BARVANJE

LAKIRANJE

PLASTIFICIRANJE

KOVINSKE
PREVLEKE

EMAJLIRANJE

CINKANJE

KOSTRANJE

KROMIRANJE

POVRŠINSKA ZAŠČITA

- BARVANJE
- LAKIRANJE
- EMAJLIČIRANJE



POVRŠINSKA ZAŠČITA

- NANOS NERJAVEČE KOVINE
- PLASTIFICIRANJE

